

Features

- Schottky barrier diodes
- Heatsink design
- Low forward voltage drop
- Low leakage current
- Moisture sensitivity: level 1, per J-STD-020
- Solder dip 260 °C, 10 s
- Low profile - typical height of 1.1 mm
- Halogen-free according to IEC 61249-2-21 definition
- High temperature soldering guaranteed: 260°C/10 seconds

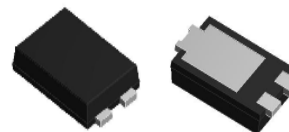

eSGC (TO-277)

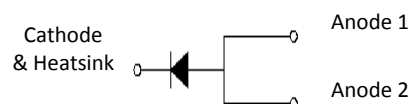

Typical Applications

For low voltage high frequency inverters, DC/DC converters and polarity protection application.

Maximum Ratings (TA = 25 °C unless otherwise noted)				
Parameter	Symbol	SGC1050S	SGC1060S	Unit
Maximum repetitive peak reverse voltage	VRRM	50	60	V
Maximum RMS voltage	VRMS	35	42	V
Maximum DC blocking voltage	VDC	50	60	V
Maximum average forward rectified current	IF(AV)	10.0		A
Peak forward surge current 8.3 ms single half sine-wave superimposed on rated load	IFSM	280		A
Operating junction and storage temperature range	TJ, TSTG	-55 to +150		°C

Electrical Characteristics (TA = 25 °C unless otherwise noted)						
Parameter	Test Conditions		Symbol	TYP.	MAX.	Unit
Maximum instantaneous forward voltage	I _F =1A	T _A =25°C	V _F	0.30	0.35	Volts
	I _F =2A			0.33	0.38	
	I _F =10A			0.46	0.5	
	I _F =1A	T _A =125°C		0.20	-	
	I _F =2A			0.24	-	
	I _F =10A			0.45	-	
Maximum DC reverse current at rated DC blocking voltage	Rated VR	T _A =25°C	I _R	0.075	0.3	mA
		T _A =125°C		16	50	
Typical junction capacitance	4.0 V, 1 MHz		C _J	540		pF
Typical thermal resistance ¹⁾	junction to lead		R _{θJL}	20		°C/W

Note1) Thermal resistance R_{θJL} is junction to lead, mounted on P.C.B with 30*30mm copper pad area



SGC1050S thru SGC1060S

Surface Mount Schottky Rectifier
Reverse Voltage 50~60V Forward Current 10A

Ratings and Characteristics Curves

(TA = 25°C unless otherwise noted)

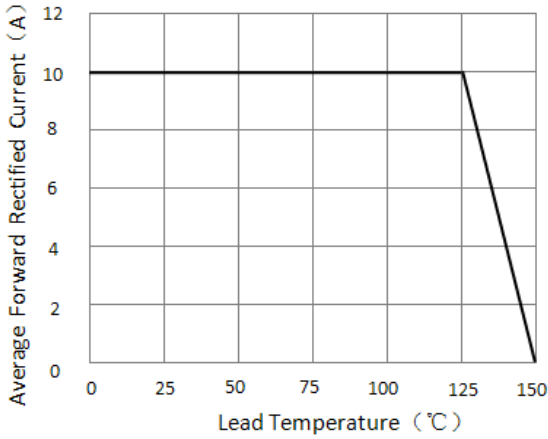

Figure 1. Forward Current Derating Curve

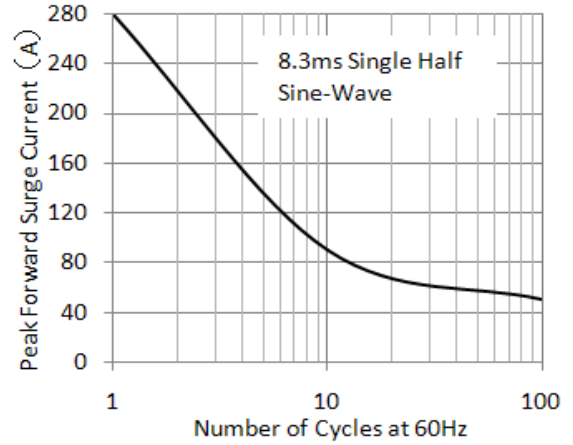

Figure 2. Maximum Non-Repetitive Peak Forward Surge Current

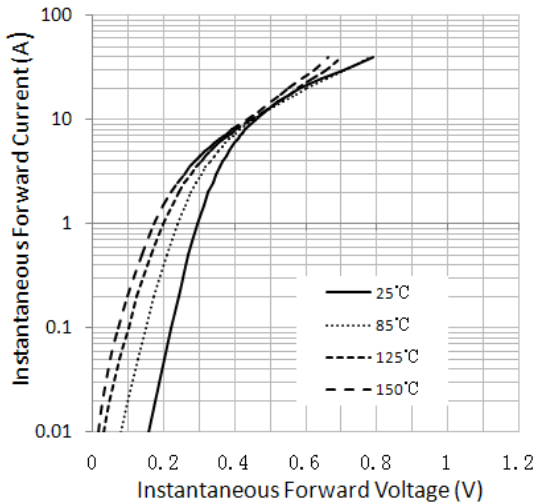

Figure 3. Typical Instantaneous Forward Characteristics

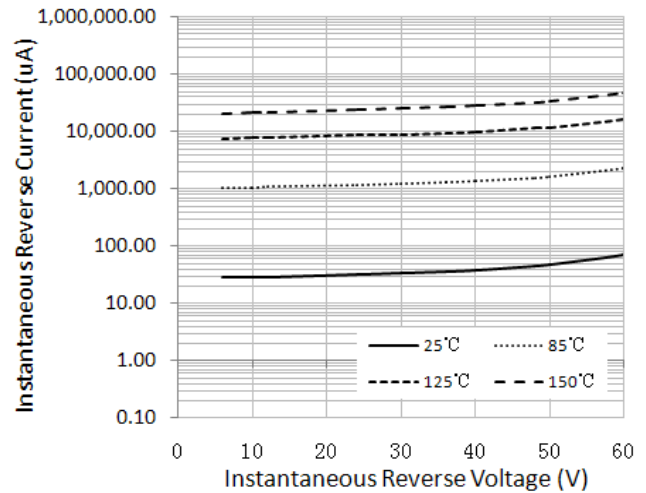

Figure 4. Typical Reverse Characteristics

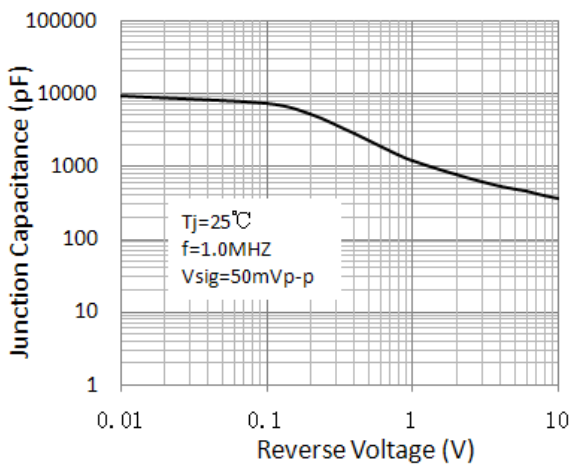
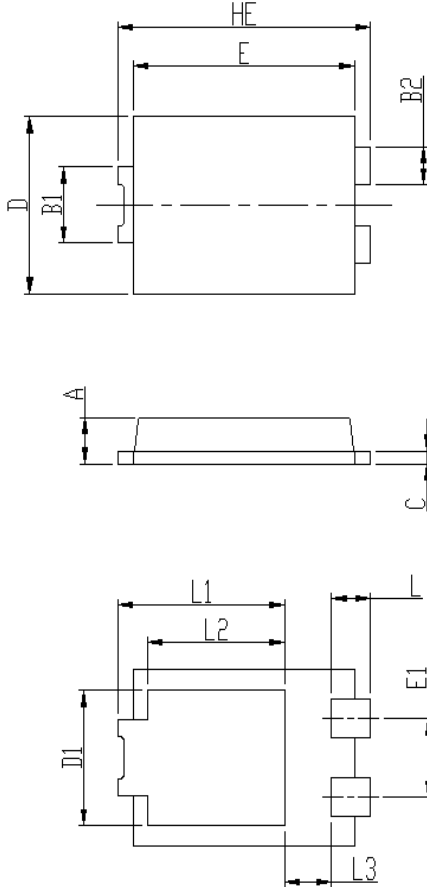

Figure 5. Typical Junction Capacitance

Package Outline Dimensions



DIM	Unit: mm		Unit: inch	
	MIN	MAX	MIN	MAX
HE	6.4	6.6	0.252	0.260
E	5.6	5.8	0.220	0.228
D	4.1	4.3	0.161	0.169
B1	1.7	1.9	0.067	0.075
B2	0.8	1	0.031	0.039
A	1.05	1.2	0.041	0.047
C	0.3	0.4	0.012	0.016
L	0.85	1.1	0.033	0.043
L1	4.2	4.4	0.165	0.173
L2	3.52 Typ.		0.139 Typ.	
L3	1.1	1.4	0.043	0.055
D1	3	3.3	0.118	0.130
E1	1.86 Typ.		0.073 Typ.	

Soldering footprint

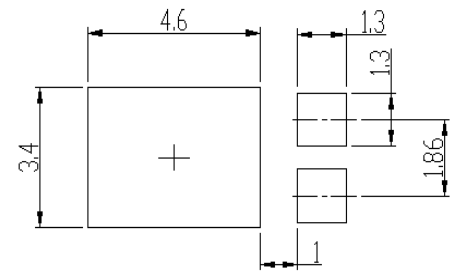

Packing Information

Packing quantities:

5000 pcs/Reel, 12mm Tape, 13" Reel

Tape & Reel Specification

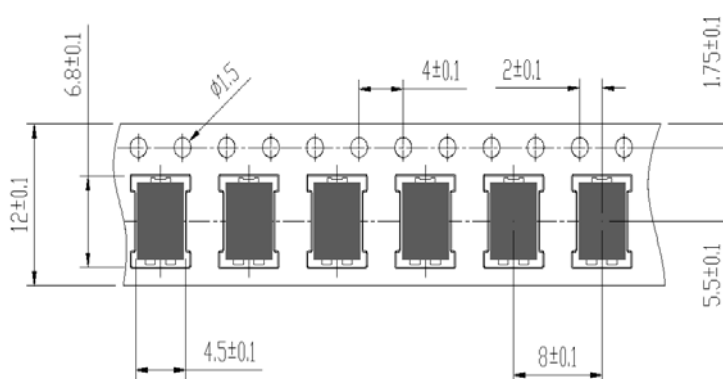



SGC1050S thru SGC1060S

Surface Mount Schottky Rectifier
Reverse Voltage 50~60V Forward Current 10A

Disclaimers

These materials are intended as a reference to assist our customers in the selection of the Suzhou Good-Ark product best suited to the customer's application; they do not convey any license under any intellectual property rights, or any other rights, belonging to Suzhou Good-Ark Electronics Co., Ltd. or a third party.

Suzhou Good-Ark Electronics Co., Ltd. assumes no responsibility for any damage, or infringement of any third-party's rights, originating in the use of any product data, diagrams, charts, programs, algorithms, or circuit application examples contained in these materials.

All information contained in these materials, including product data, diagrams, charts, programs and algorithms represents information on products at the time of publication of these materials, and are subject to change by Suzhou Good-Ark Electronics Co., Ltd. without notice due to product improvements or other reasons. It is therefore recommended that customers contact Suzhou Good-Ark Electronics Co., Ltd. or an authorized Suzhou Good-Ark Electronics Co., Ltd. for the latest product information before purchasing a product listed herein. The information described here may contain technical inaccuracies or typographical errors. Suzhou Good-Ark Electronics Co., Ltd. assumes no responsibility for any damage, liability, or other loss rising from these inaccuracies or errors. Please also pay attention to information published by Suzhou Good-Ark Electronics Co., Ltd. by various means, including our website home page.

(<http://www.goodark.com>)

When using any or all of the information contained in these materials, including product data, diagrams, charts, programs, and algorithms, Please be sure to evaluate all information as a total system before making a final decision on the applicability of the information and products. Suzhou Good-Ark Electronics Co., Ltd. assumes no responsibility for any damage, liability or other loss resulting from the information contained herein.

The prior written approval of Suzhou Good-Ark Electronics Co., Ltd. is necessary to reprint or reproduce in whole or in part these materials.

Please contact Suzhou Good-Ark Electronics Co., Ltd. or an authorized distributor for further details on these materials or the products contained herein.